



NAOTEC

NATURE & TECHNOLOGIE

VITICULTURE

TRIMMERS – PREPRUNERS – SHREDDERS – SHOOT THINNERS – ALL-IN-ONE

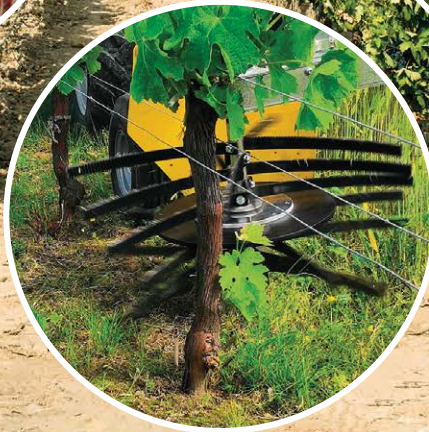

« HARNESSING **TECHNOLOGY** IN SERVICE OF **NATURE** »

TRIMMERS – HARVESTERS-STRADDLE TRACTOR



 NAOTEC offers a wide range of trimmers for Harvesters-Straddle tractors. From 1 to 4 complete rows, many options are possible depending on the vineyard.

 Highlighted Features:

- Adaptable to all types of tractors
- Security of deletion of all the vertical cuts
- Stainless steel casing for enhanced durability.
- Constructed with robust and durable materials.
- Easily adjustable cutting height
- Low hydraulic requirement (28L/min)
- Poly v belts for improved traction.
- Very low maintenance due to the high-quality materials used.

RE100 RE200 RE270 RE300 RE370 RE400



Mounting on MAST MP4

- Double-beam frame
- Excellent visibility during work
- Height adjustment (200mm)
- Horizontal tilting of tools
- Hydraulic incline from 0° to 10°
- Connecting bar on the upper part

Mounting on MAST MP5

- Double-beam lift frame
- Excellent visibility during work
- Quick attachment of tools
- Lift height of 1500mm or 1800mm depending on the model
- Hydraulic incline from 0° to 10°
- Connecting bar on the upper part

TRIMMERS – INTERROW TRACTOR



NAOTEC offers various models of trimmers adjustable for different vineyards from half-row to two full-row trimmers. They are all equipped with high-quality steel machinery, hydraulic spacers, slope capabilities.

Highlighted Features :

- 500mm serpes blades with a large overlap for a clean cut.
- Front or rear hitching options for convenience.
- Secure deletion of cuts to ensure safety.
- Constructed with robust and durable materials.
- Stainless steel casing for enhanced durability.
- Capability to cut at speeds up to 20 km/h.
- Easy adjustment of cutting size and angles.
- RF model is 100% scalable in time easily.
- Low hydraulic flow requirement (28L/min)
- Poly v belts for improved traction.
- Very low maintenance due to the high-quality materials used.



Hydraulic front version



Hydraulic rear version



Electric version



Mechanical version



- Hydraulic movement available for all adjustments
- Horizontal cut with automatic folding if hooked + height adjustment
- Cutting angle adjustment
- Available in a whole range of dimensions
- Large spring with rod for safety cut
- Serp blades 500mm
- Vines lifting finger

SHREDDERS (Vines and orchards)



NAOTEC specializes in manufacturing a wide range of mechanical and hydraulic Shredders specifically designed for vineyards. Similar to our other machines, these Shredders can be easily mounted on tractors or straddle carriers.

Highlighted Features :

- ♦ Very robust with a heavy weight suitable for work.
- ♦ Ranging from 0.5M for small vineyards to 2.5M for larger ones.
- ♦ Large opening of 300mm to maximize the feeder height.
- ♦ Sturdy sheet metal construction to provide durability and longevity.
- ♦ Versatile: choose between roller, wheels or pivoting wheels.
- ♦ Customizable shredding process by a selection of multiple choices of hammers
- ♦ Rigorous testing and quality control. Our shredders undergo thorough checks before leaving the factory.
- ♦ Height-adjustable skids to adapt to vineyard requirements.

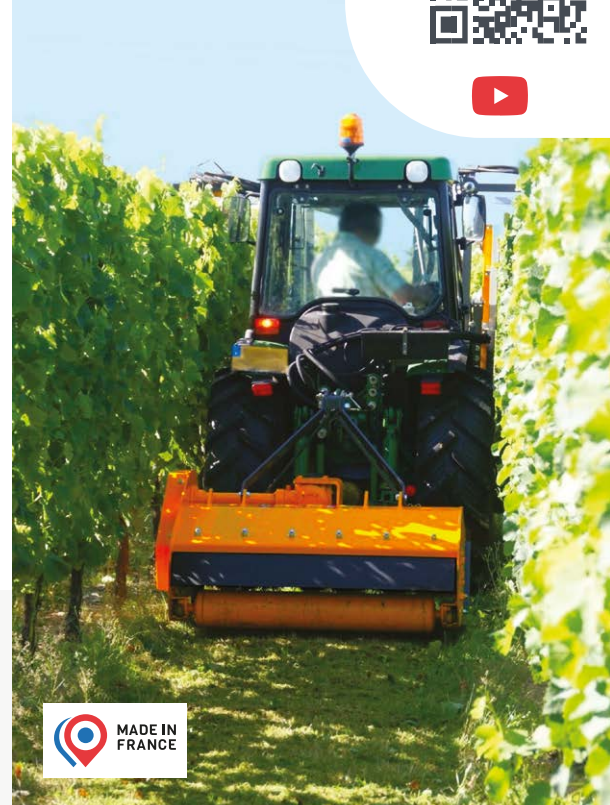

Vine shoot



Grass



Crop canopy



Branches



Choose your model



Hammer
Vine shoot
Grass



Spoon blade
Grass



Y blade
Crop canopy



Blade on Torve shackle
Grass

Special vine shoots



BSH
(From 500 to 750mm)
Vine shoot

Mounting on
Straddle carrier



BSM
(From 950 to 1700mm)
Vine shoot

Special grass (specific Rotor in option)



BHH
(From 500 to 1050mm)
Grass
Vine shoot

Mounting on
Straddle carrier



BHM / BHH
(From 900 to 2200mm)
Grass
Vine shoot



BHMF
(From 900 to 1600mm)
Grass
Vine shoot



BVA
(From 1600 to 2500mm)
Grass
Vine shoot
Branches

PREPRUNERS



NAOTEC has pioneered the technology of double discs, to efficiently shorten vine shoots, making manual vine pruning easier and faster. The cutting heights can be customized and easily adjusted according to specific requirements.

Highlighted Features :

- Double disc technology that eliminates tendrils entangled around the wires.
- Significant reduction in labor time.
- Speed controlled by an accumulator.
- Low oil flow.
- Capability to cut even with vegetation.
- Different mast options available.
- Precise pre-cutting facilitated by adjustable settings.
- Streamlined design to prevent wires from being carried away.
- Pendulum system to follow slopes.
- Various pole opening options (manual, mechanical, or electromagnetic).

DOUBLE DISC TECHNOLOGY

Experience the unique combination of double disc NAOTEC technology with counter blade discs on one side and cutting discs on the other. Our technology ensures a clean and precise cut every time, without any worries of snagging or tangling wires.

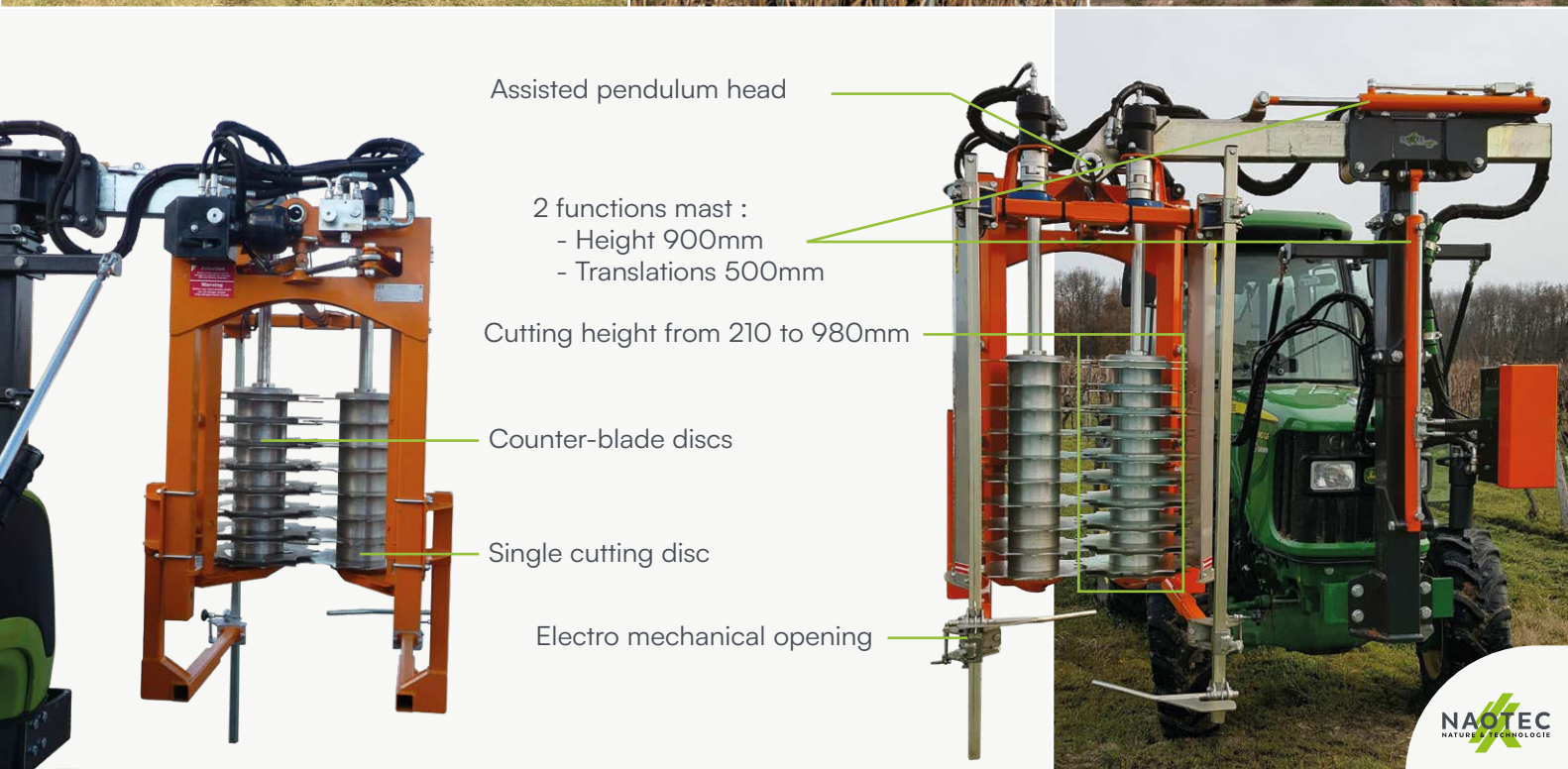

SHOOT THINNERS



NAOTEC offers a full-row and a two half-row shoot thinner, both equipped with rotary brushes technology designed to provide gentle and vibration-free treatment for the vines. Connecting the machine to the tractor is a breeze.

Highlighted Features :

- Eliminate non-fruiting branches and reduce vine stock obstructions.
- Front or rear hitching options, providing versatility and convenience.
- Working height can be adjusted between 25 and 55 cm.
- Speed regulator included allowing precise and efficient workflow.
- Ability to halt the rotating head for new plants.
- High-quality rotary brushes with strips, guaranteeing excellent results.
- Easily modifiable and adjustable for each vineyard.
- Anti-winding discs to safeguard from potential damage.
- Automatic head retraction in case of collision.
- Ensure a more environmentally friendly approach without chemical products.



ALL-IN-ONE

Mounting on :

- Shoot thinners **EL-P**
- Trimmer **RL**
- Prepruner **DL-P**



MAST MP1

- Versatile and multi-purpose functionality
- Single-beam, simple and robust design
- Front or inter-wheel mounting options
- Hydraulic upward and downward function (optional translation mode)
- High-pressure filter
- Supplied with shrouds
- Optional joystick (4 DE)
- Drop-off support

Mounting on :

- Trimmer **RG-P**
- Prepruner **DL-P**



MAST MP6

- Sturdy and reliable single-beam design (Z dynamic) for enhanced performance
- Front-mounting
- Upward and downward function with a stroke of 600mm, ensuring precise control
- Mast inclination for easy transport positioning
- Tool inclination function for versatile operation
- Optional joystick available for control (3 DE)
- Drop-off support



CUSTOM MACHINES



RK120 (SPECIAL KIWI)

Interchangeable blades (knives or blades).
Adjustment of the cutting angles to adapt
to any type of plantation.

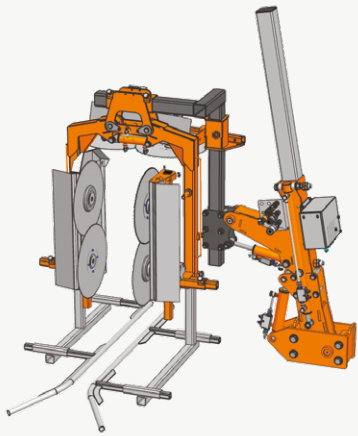
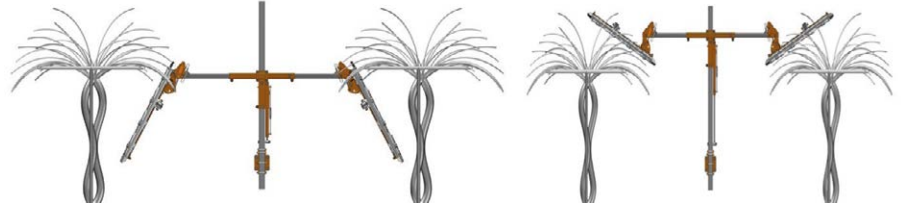
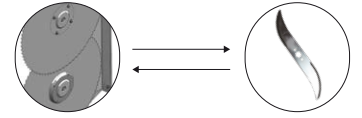

BOX PRUNER

Machine designed for short pruning of high
cordon vines. Specially for non-trellised vines

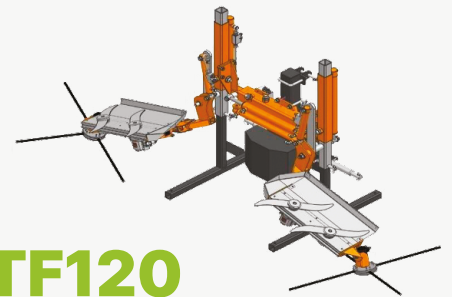

TF120

Two rows pruner under cordon



RP (SPECIAL NURSERY)

Machine built to trim nursery with row, angle and height adjustment.



RP100
1 row



RP200
2 rows



RP470
4 rows





Distributed worldwide by a large international network of distributors.



 +33 (0)5 46 90 88 30

 contact@naotec.com

 ZI du Chail, 17800 Pons (FRANCE)

 www.naotec.com

With a solid presence in both the French and international markets, Naotec takes pride in delivering top-notch equipment that enhances productivity and ensures exceptional results in vineyard operations.

At Naotec, we prioritize customer satisfaction and strive to build long-lasting relationships with our clients. Our friendly and knowledgeable team is dedicated to provide the best solutions tailored to your specific requirements.

Join countless vineyard owners and professionals who have placed their confidence in us as their preferred equipment supplier.

